

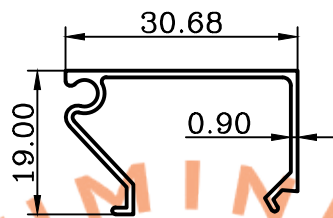

# Catalog 2021

PT. HP METALS INDONESIA

SHOP FRONT 3" X 1.5"



7 1 3 6

W = 0.200 Kg/M

P = 154.360 mm

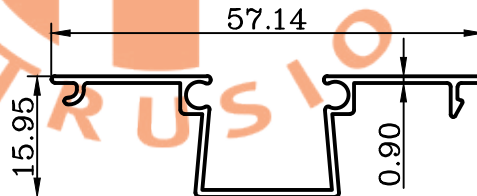
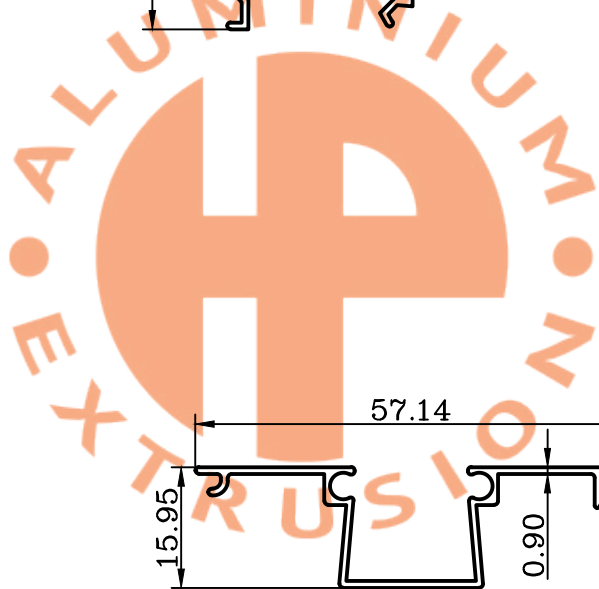

7 1 3 8

W = 0.255 Kg/M

P = 204.180 mm

# ASSEMBLY SHOP FRONT 4" X 1.75"

FRONT ELEVATION

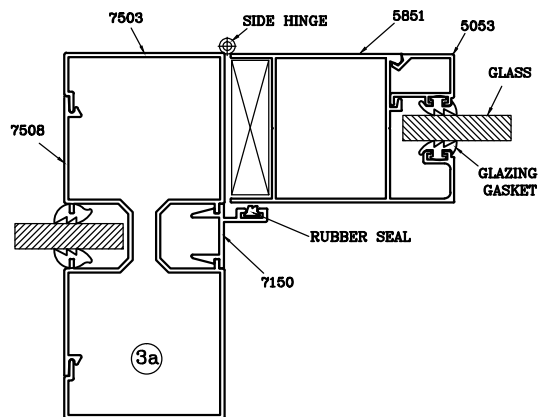
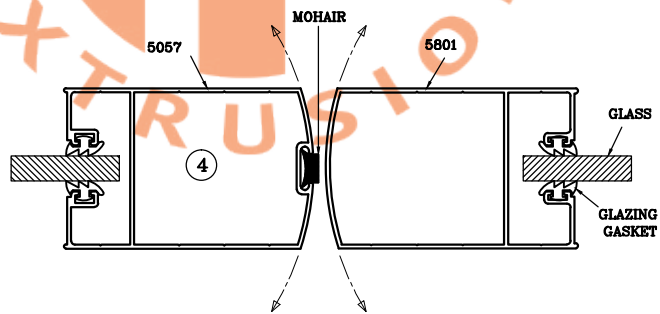
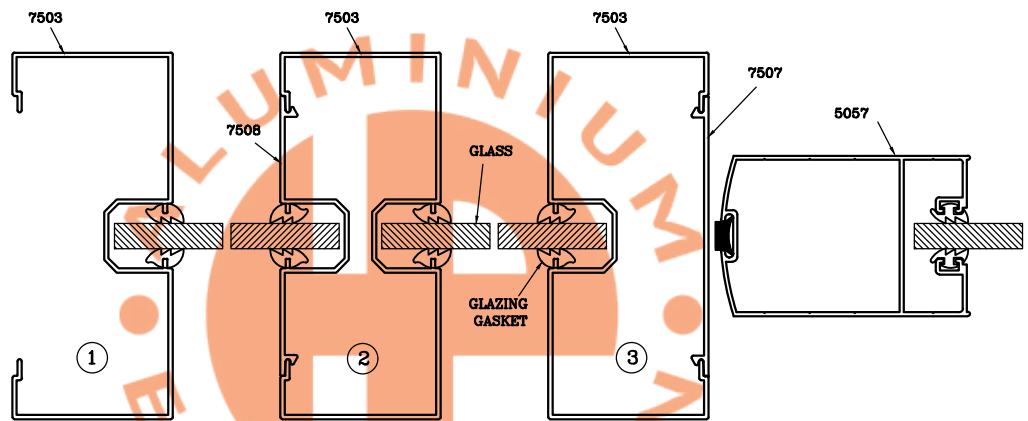
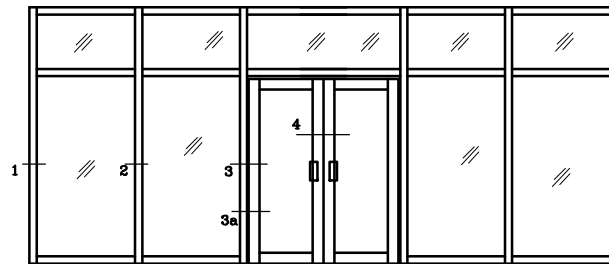

# ASSEMBLY SLIDING DOORS

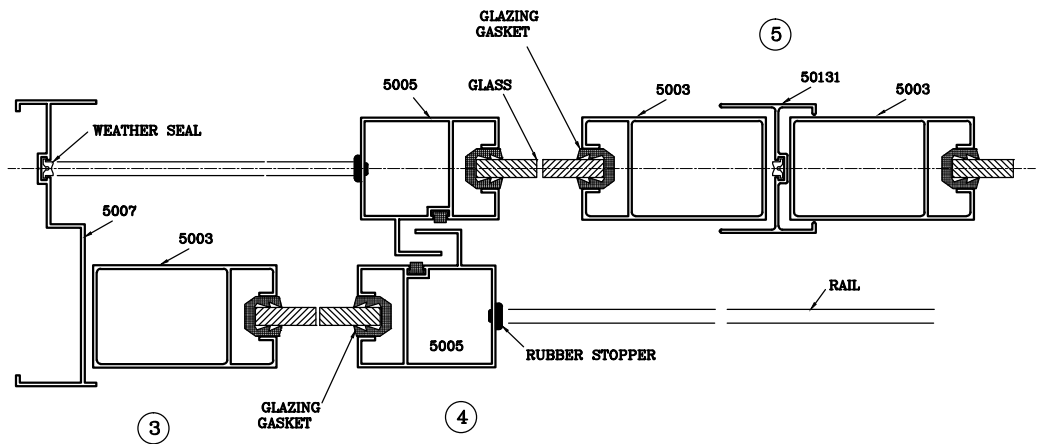
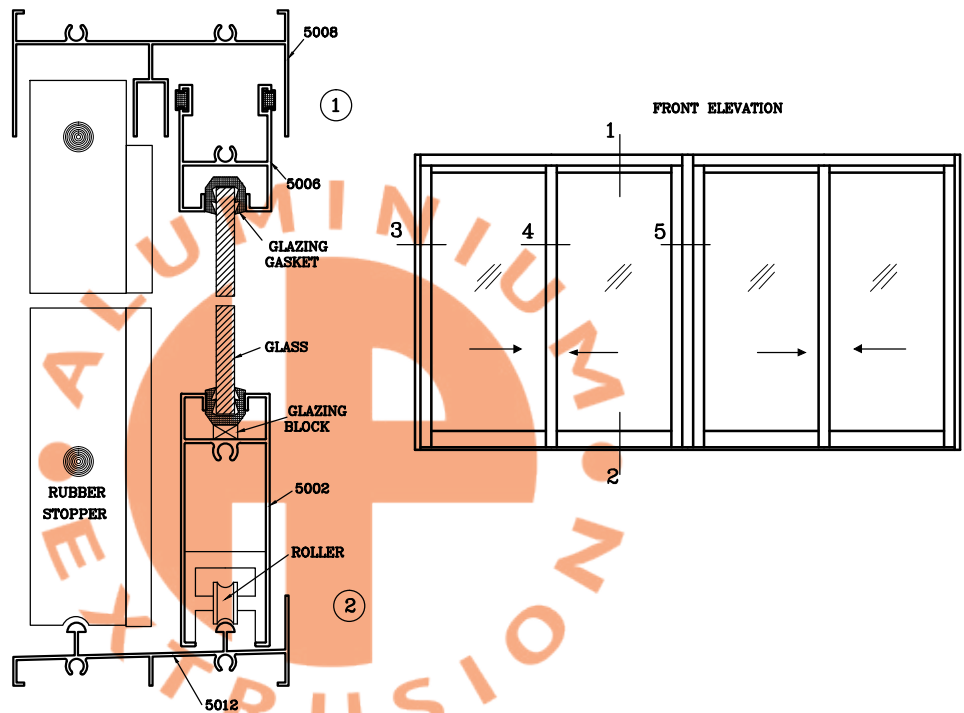

# CURTAIN WALL

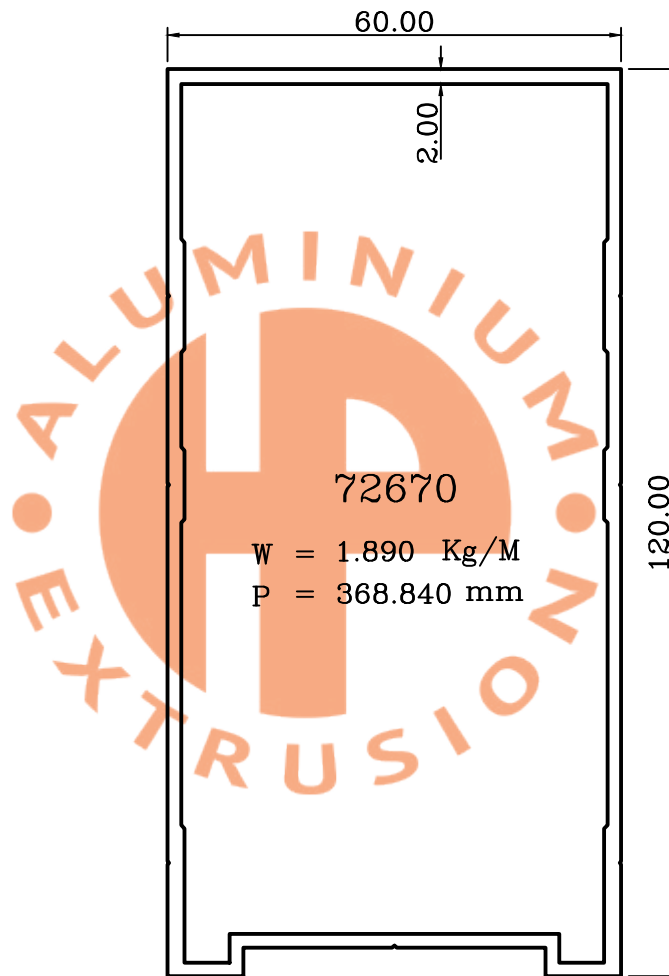

# SHOP FRONT 3" X 1.5"

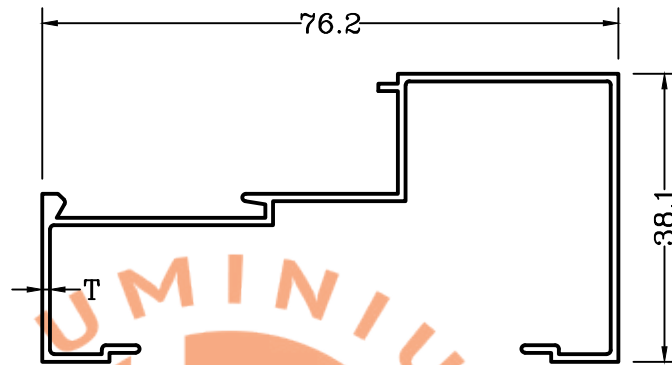

NO SECTION	T mm	W Kg/M	P mm
7101 A	0.90	0.469	369.47
7101	1.00	0.519	368.613

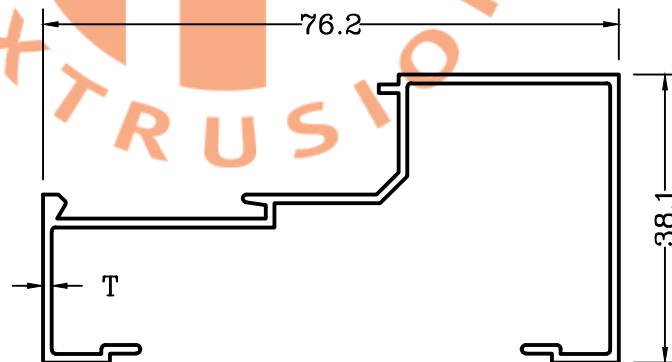

NO SECTION	T mm	W Kg/M	P mm
71011 A	0.90	0.464	365.85
71011	1.00	0.511	365.129
7109 A	1.10	0.558	366.25
7109	1.15	0.582	365.84
71091	2.00	0.926	356.510

# SHOP FRONT 76.2mm X 37mm

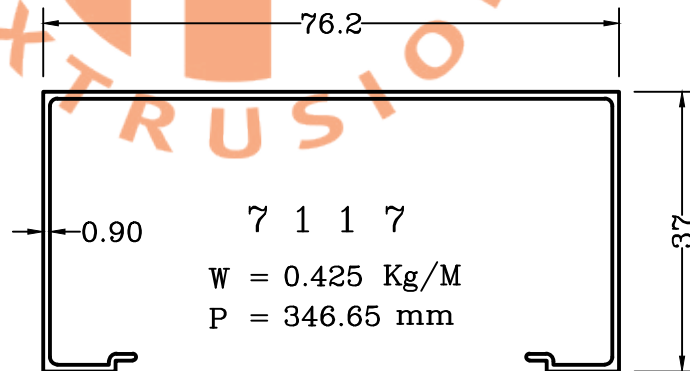
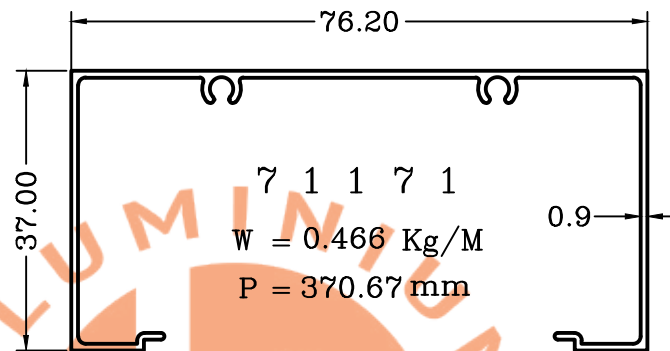



For the full version of the  
catalog please kindly  
contact our team.

Untuk katalog versi lengkap, silahkan hubungi tim kami.